



47177 Conrad Anderson Rd
Hammond, LA 70401

www.heckerridgetiles.com

800.248.4537

INSTALLATION MANUAL

INDEX:

1. SHINGLE PREPARATION
2. "V" TILE 90° CUT SHEET
3. "V" TILE 115° CUT SHEET
4. "V" TILE FASTENER DETAIL
5. "V" TILE ASSEMBLY
6. "V" TILE ROOF CONDITIONS & 3 WAY MITER DETAIL
7. LAP RIDGE TILE CUT SHEET
8. LAP RIDGE TILE FASTENER DETAIL
9. LAP RIDGE TILE ASSEMBLY
10. LAP RIDGE TILE ROOF CONDITIONS & 3 WAY MITER DETAIL

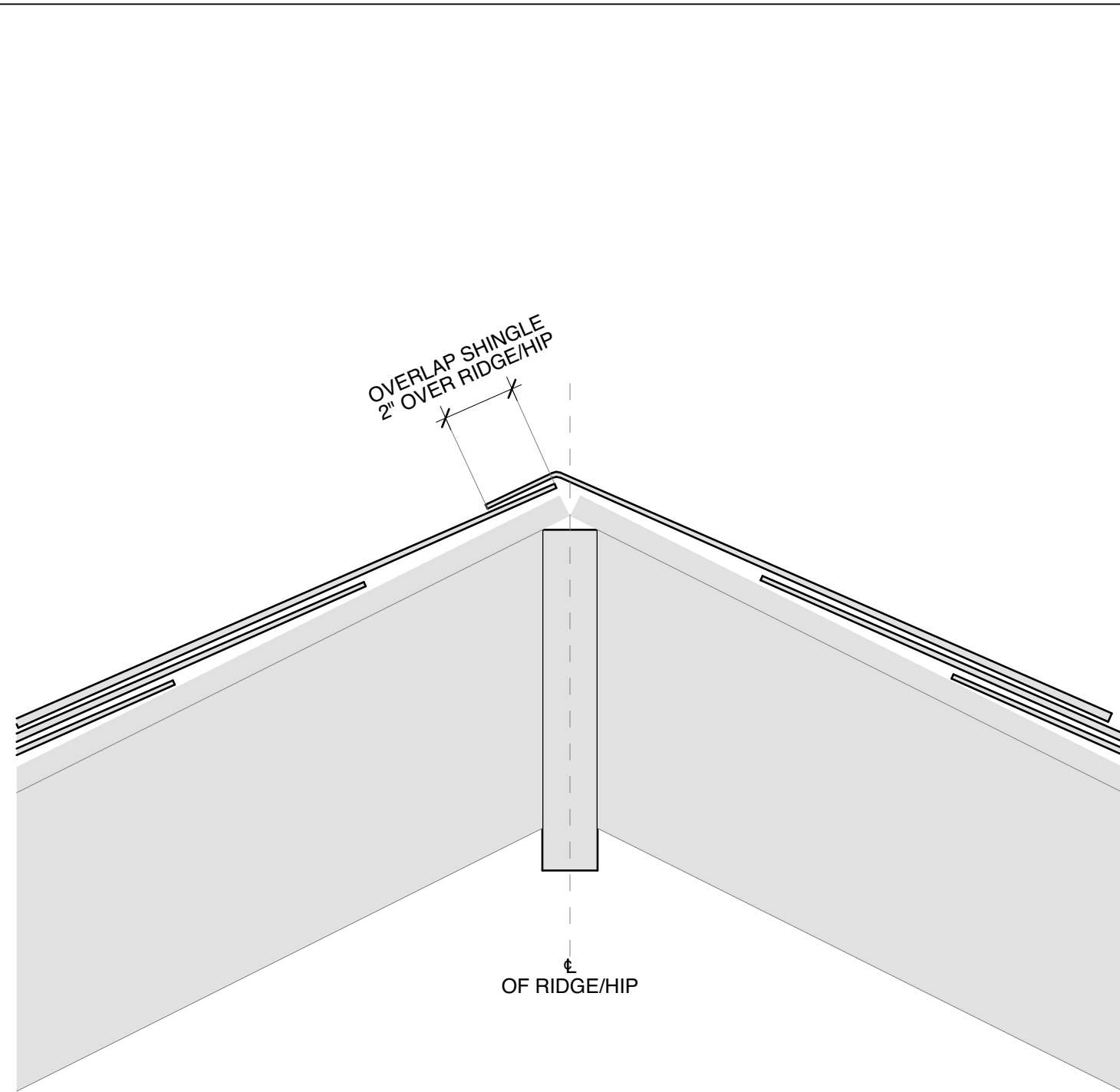

FIGURE 1

NOTE: CUT SHINGLES EVEN ON ONE SIDE OF THE HIP/RIDGE. LAP OTHER SIDE APPROX. 2" OVER AND NAIL OVERLAP SHINGLE EVERY 5" FROM BOTTOM TO TOP WITH ROOFING NAILS. (DO NOT LEAVE EXPOSED NAILS)

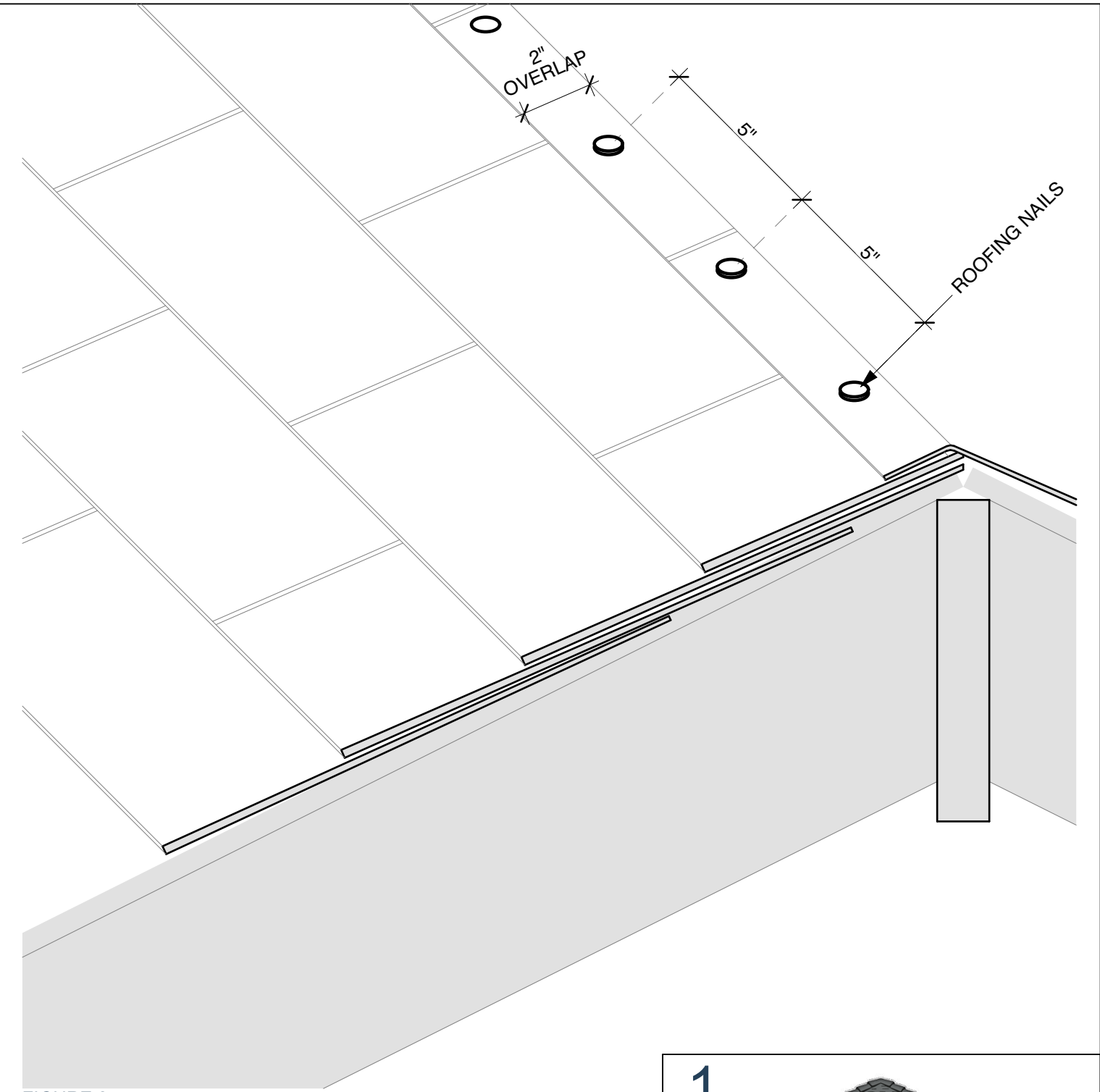

FIGURE 2

NOTE: FOR WOOD CONSTRUCTION ONLY

RIDGE TILE ASSEMBLY

SHINGLE PREPARATION (TYPICAL)

1

HECKER
RIDGE TILES

HECKER RIDGE TILES
www.heckerridgetiles.com
800.248.4537

FRONT VIEW

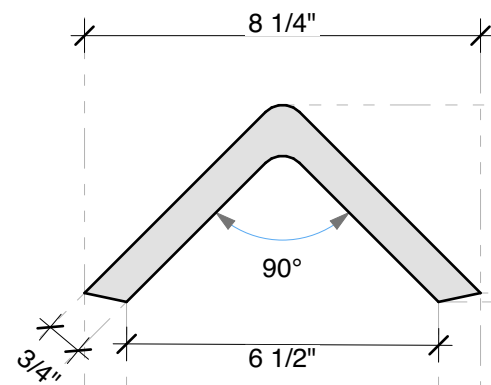

SIDE VIEW

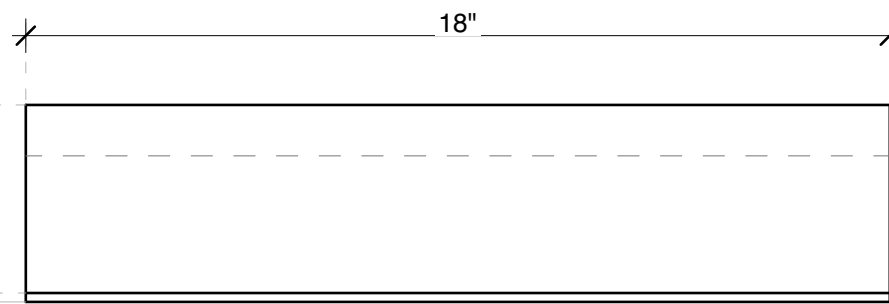

TOP VIEW

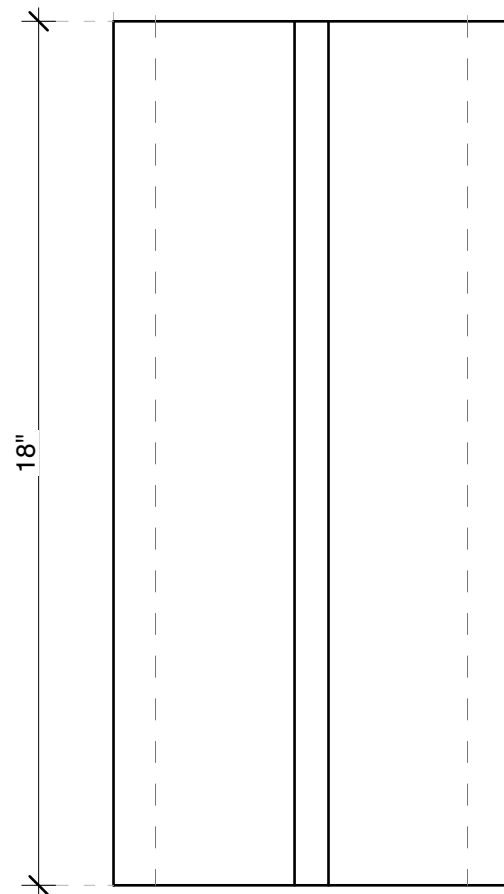

WEIGHT PER PIECE - 11.1 LB

MIN. ROOF SLOPE - 3:12

BASE TEXTURE: SMOOTH

COLOR BLENDS - CHARCOAL, DARK BROWN, LIGHT BROWN, TERRACOTTA RED
MATERIAL: CONCRETE

"V" TILE 90°

2



HECKER RIDGE TILES
www.heckerridgetiles.com
800.248.4537

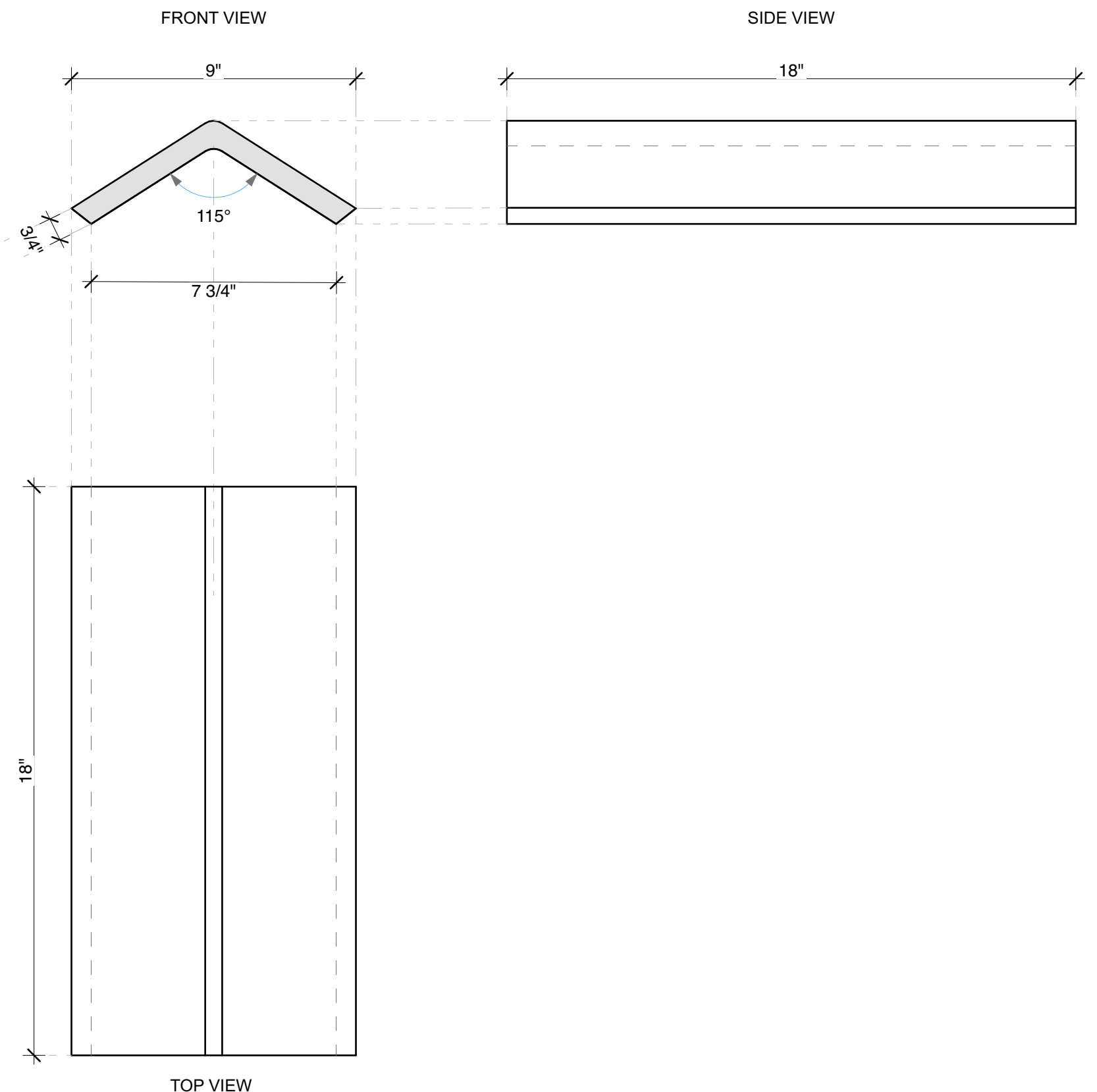

WEIGHT PER PIECE - 9.2 LB
 MIN. ROOF SLOPE - 3:12
 BASE TEXTURE: SMOOTH

COLOR BLENDS - CHARCOAL, DARK BROWN, LIGHT BROWN, TERRACOTTA RED
 MATERIAL: CONCRETE

"V" TILE 115°

3

HECKER
RIDGE TILES

HECKER RIDGE TILES
www.heckerridgetiles.com
 800.248.4537

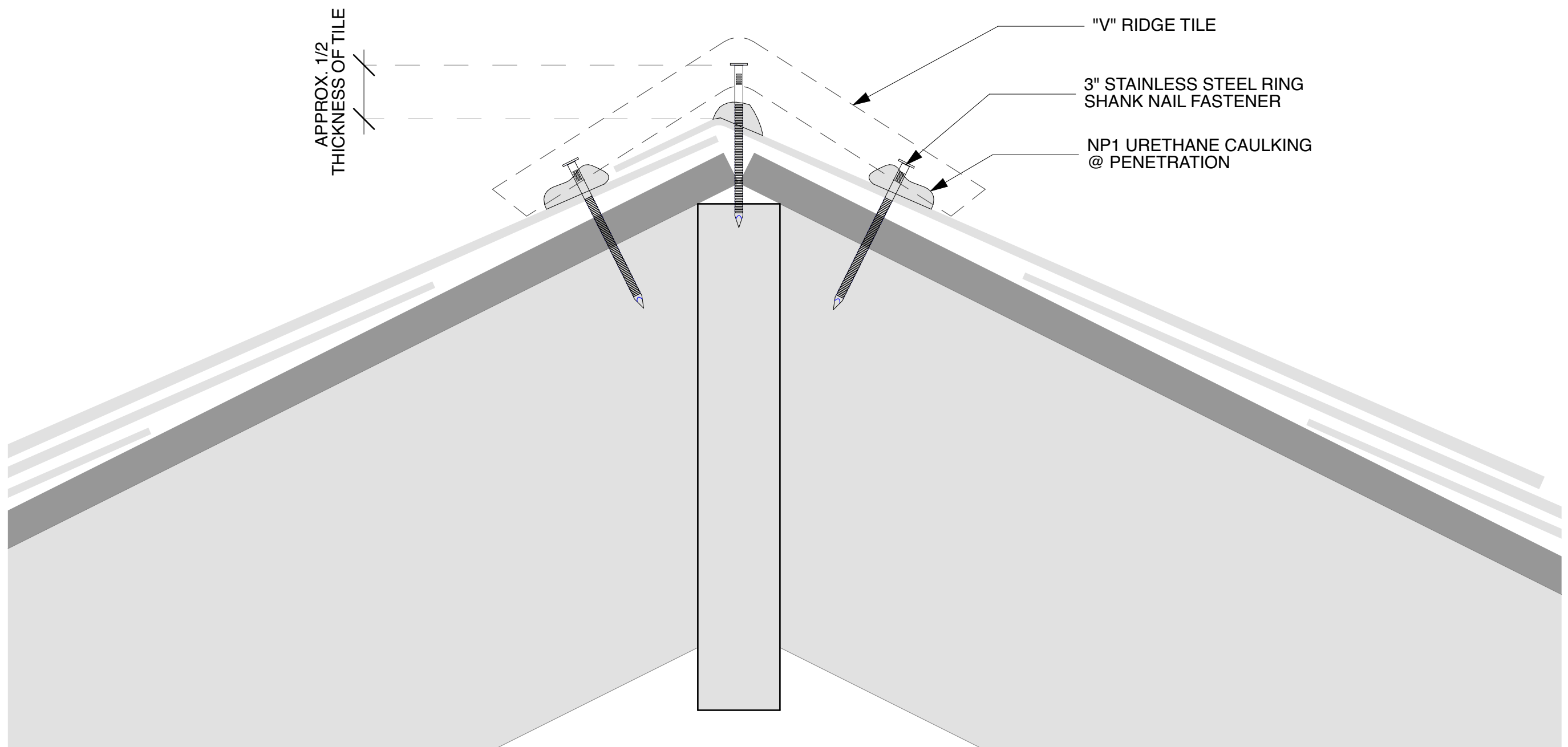

FIGURE 1

NOTE:

USE (3) STAINLESS STEEL RING SHANK NAILS W/ NP1 URETHANE CAULKING WHERE NAIL PENETRATES THE SHINGLE AND ROOF DECKING TO FASTEN TILES TO ROOF.

STAINLESS STEEL RING SHANK NAILS TO BE INSTALLED APPROX. HALF WAY THE THICKNESS OF THE TILE.

NOTE: FOR WOOD CONSTRUCTION ONLY

RIDGE TILE ASSEMBLY

"V" TILE FASTENER DETAIL

4



HECKER RIDGE TILES
www.heckerridgetiles.com
 800.248.4537

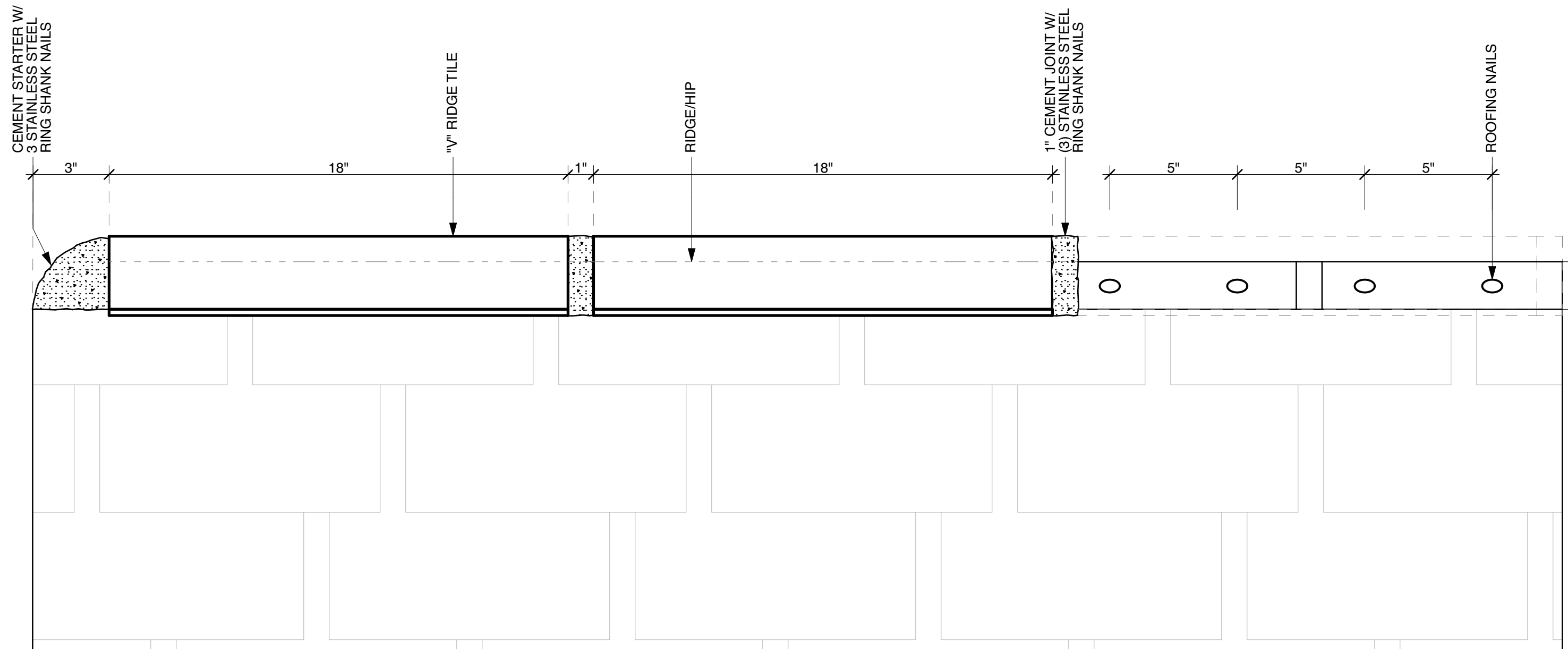

FIGURE 1

NOTE:

MIX TWO PARTS SAND WITH 1 PART PORTLAND TYPE 1-2 CEMENT TO BE USED @ JOINTS, MITER 3 WAYS, AND HIP/ GABLE STARTERS.

JOINTS TO BE APPROX. 1" WIDTH FROM THE TOP OF THE TILE DOWN TO THE SHINGLE ROOF.

CEMENT HIP/GABLE STARTER USING (3) 3" STAINLESS STEEL RING SHANK NAILS WITH NP1 URETHANE CAULKING @ ROOF PENETRATION.



HECKER RIDGE TILES
www.heckerridgetiles.com
 800.248.4537

NOTE: DO NOT BLOCK WATER ON VALLEYS OR WALL FLASHINGS

RIDGE TILE ASSEMBLY

"V" TILE

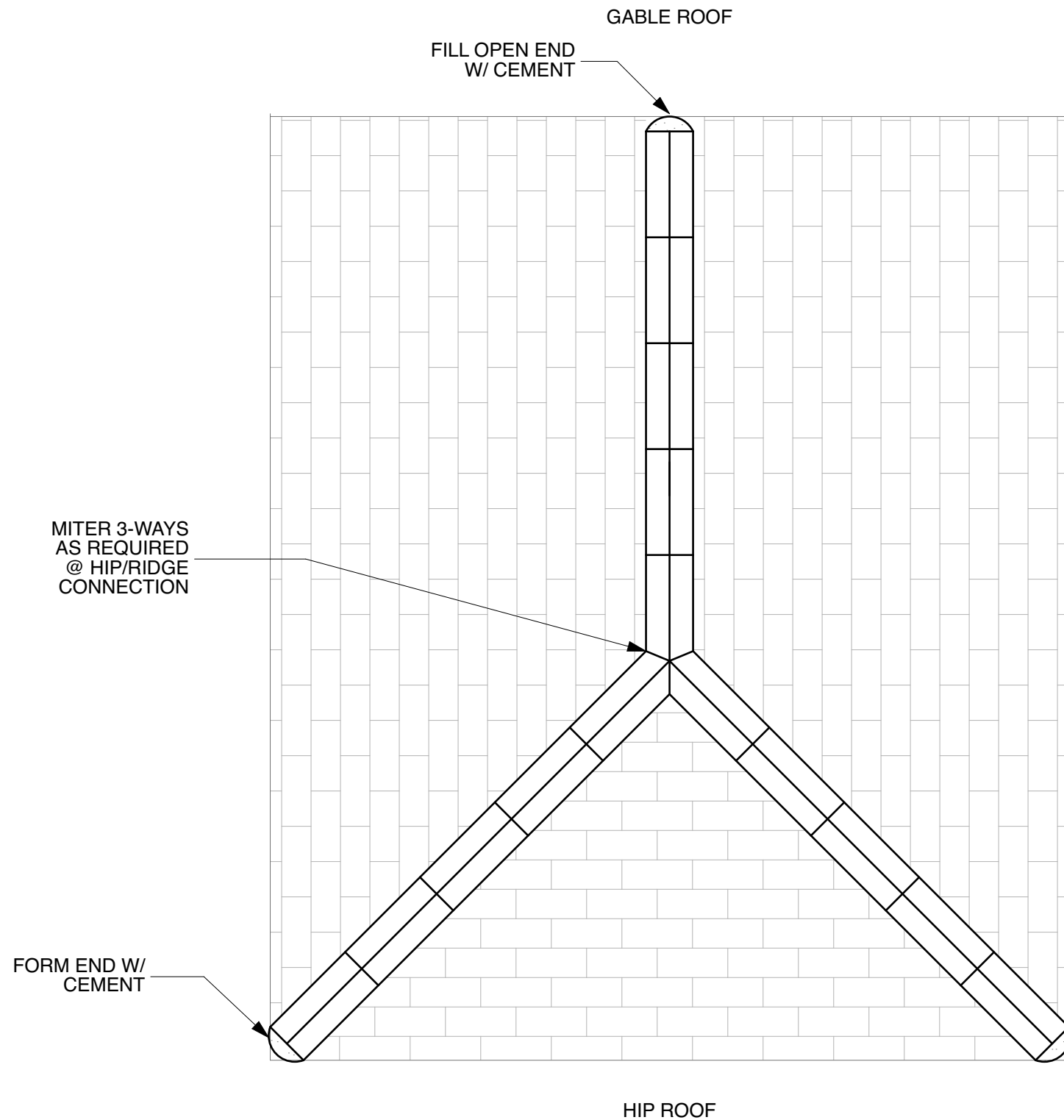
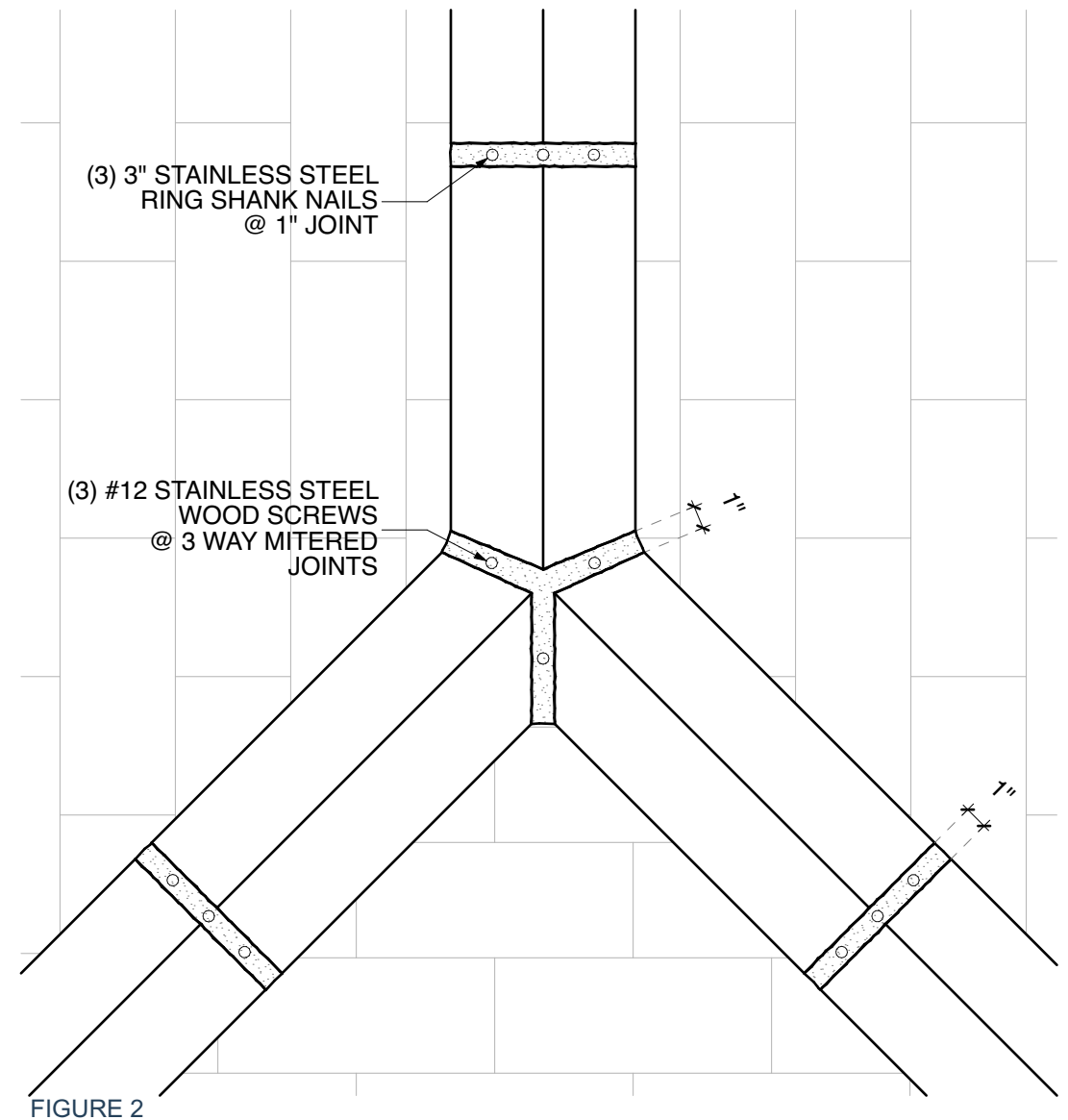

FIGURE 1



NOTE:

MITER 3 WAYS, AS NECESSARY, USING (3) # 12 STAINLESS STEEL WOOD SCREWS W/ NP1 URETHANE CAULKING @ ROOF PENETRATION.

USE (#) STAINLESS STEEL RING SHANK NAILS W/ NP1 URETHANE CAULKING @ ROOF PENETRATION

FILL 1" JOINTS W/ 2 PART SAND & 1 PART PORTLAND TYPE 1-2 CEMENT MIXTURE.

NOTE: FOR WOOD CONSTRUCTION ONLY

"V" RIDGE TILE - ROOF CONDITIONS & 3 WAY MITER DETAIL

6



HECKER RIDGE TILES
www.heckerridgetiles.com
 800.248.4537

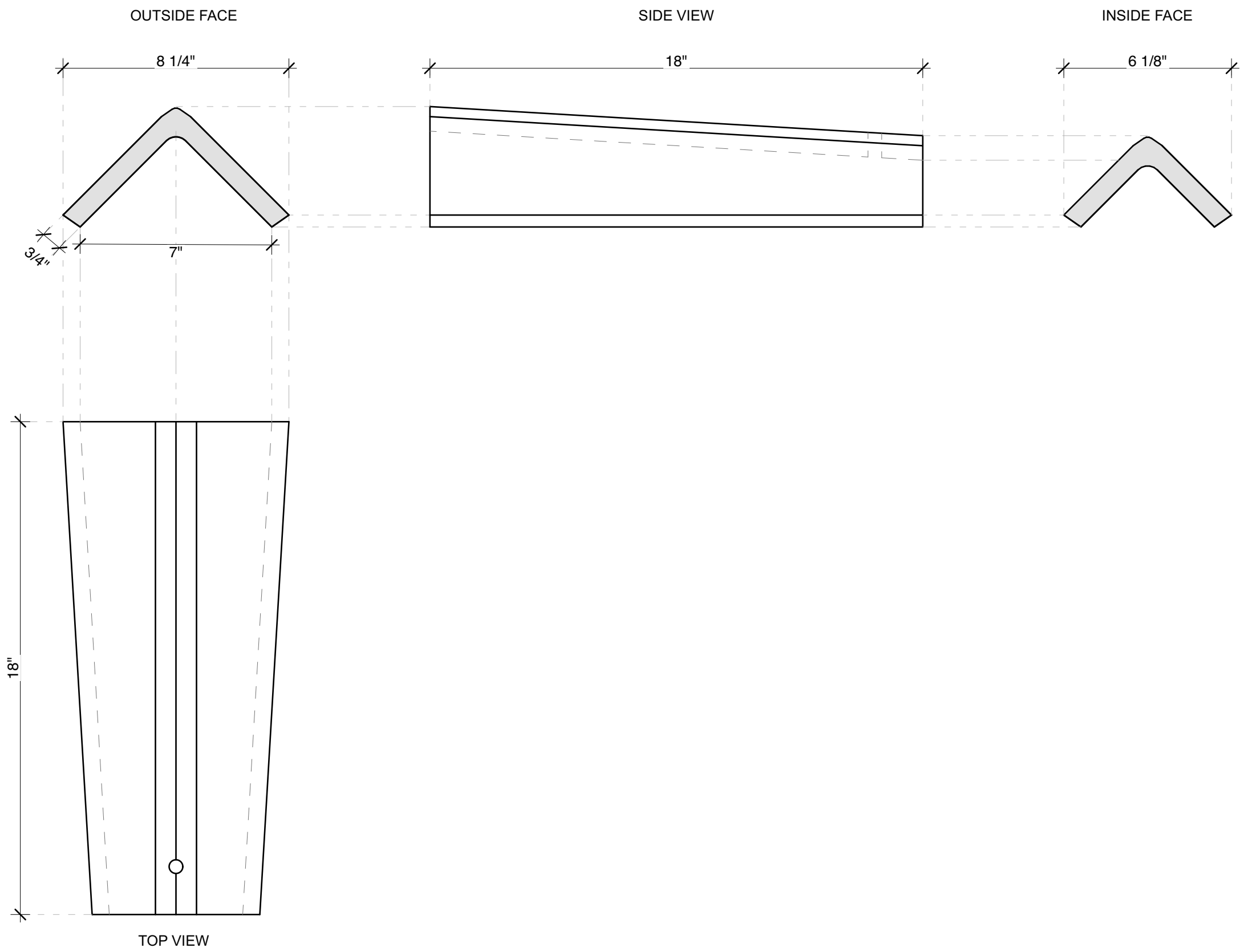

WEIGHT PER PIECE - 10.4 LB
 MIN. ROOF SLOPE - 3:12
 BASE TEXTURE: SMOOTH

COLOR BLENDS - CHARCOAL, DARK BROWN, LIGHT BROWN, TERRACOTTA RED
 MATERIAL: CONCRETE

LAP RIDGE TILE

7

HECKER
RIDGE TILES

HECKER RIDGE TILES
www.heckerridgetiles.com
 800.248.4537

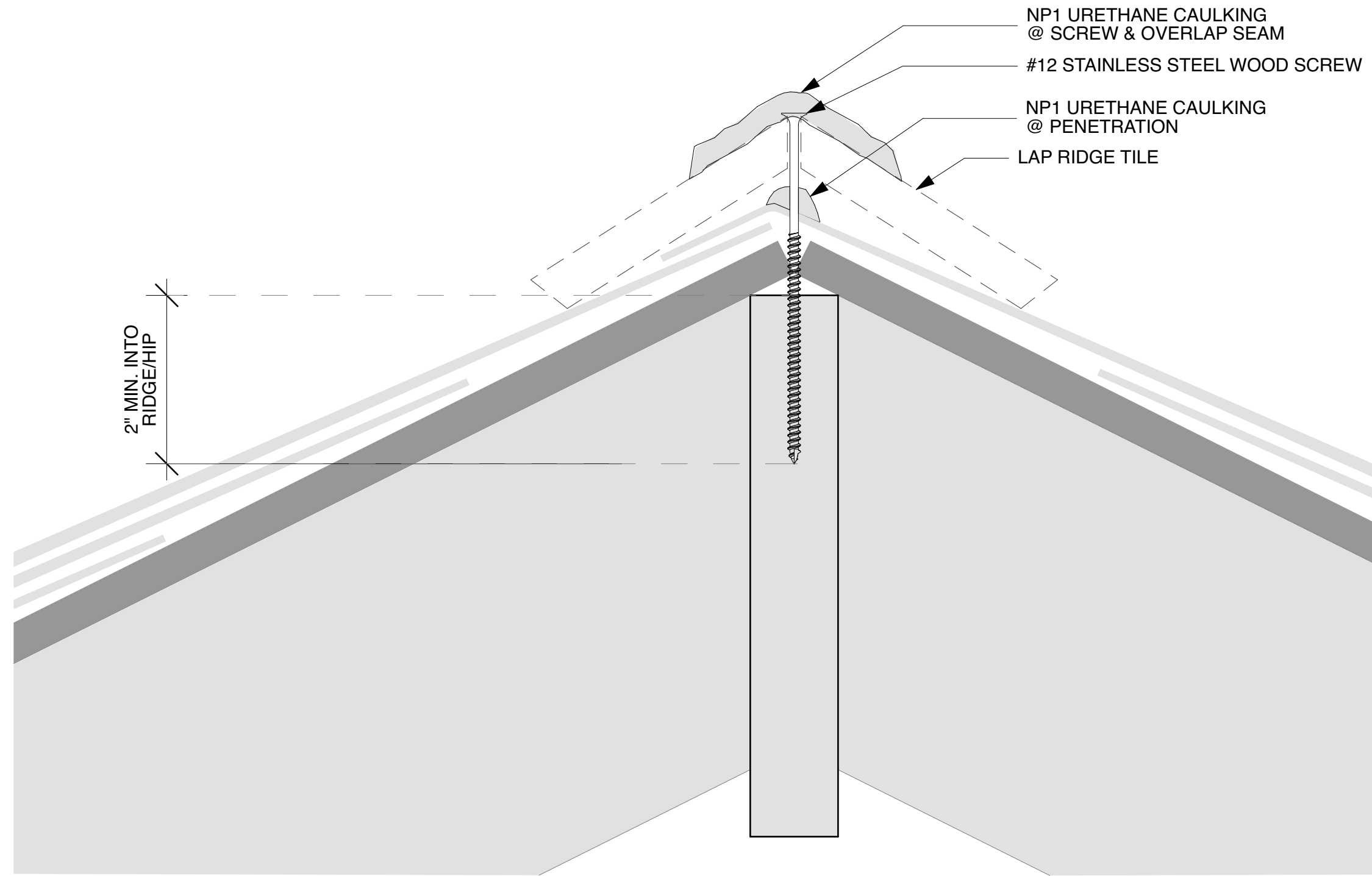

FIGURE 1

NOTE:
USE #12 STAINLESS STEEL WOOD SCREWS TO PENETRATE HIP/RIDGE AT LEAST 2".

NP1 URETHANE CAULKING TO BE APPLIED AT ROOF PENETRATION, ALONG THE SCREW, & TO SEAL THE OVERLAP SEAM.

NP1 URETHANE CAULKING
@ SCREW & OVERLAP SEAM
#12 STAINLESS STEEL WOOD SCREW
NP1 URETHANE CAULKING
@ PENETRATION
LAP RIDGE TILE

2" MIN. INTO
RIDGE/HIP

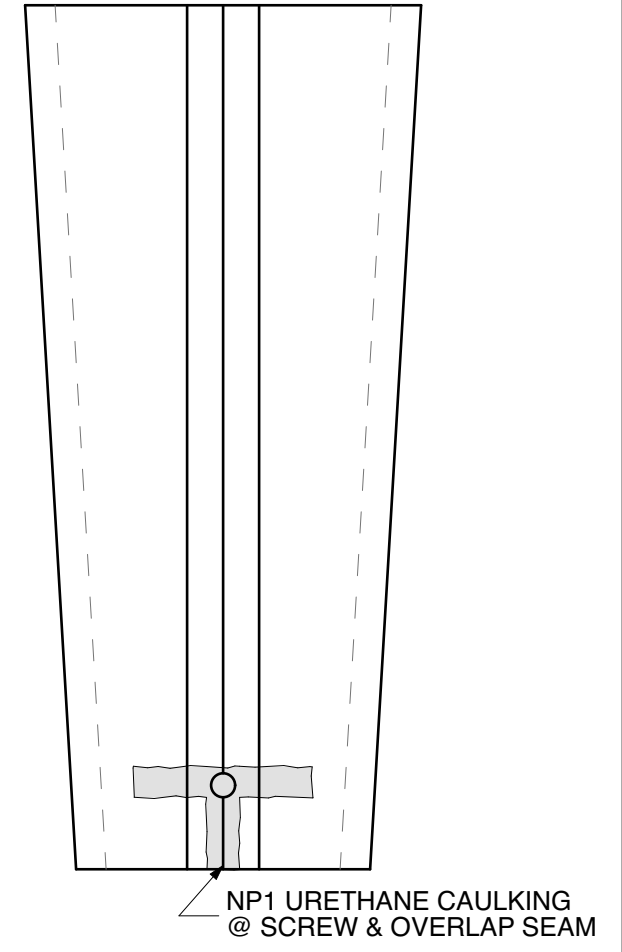

FIGURE 2

NP1 URETHANE CAULKING
@ SCREW & OVERLAP SEAM

NOTE: FOR WOOD CONSTRUCTION ONLY

RIDGE TILE ASSEMBLY

LAP RIDGE TILE FASTENER DETAIL

8



HECKER RIDGE TILES
www.heckerridgetiles.com
800.248.4537

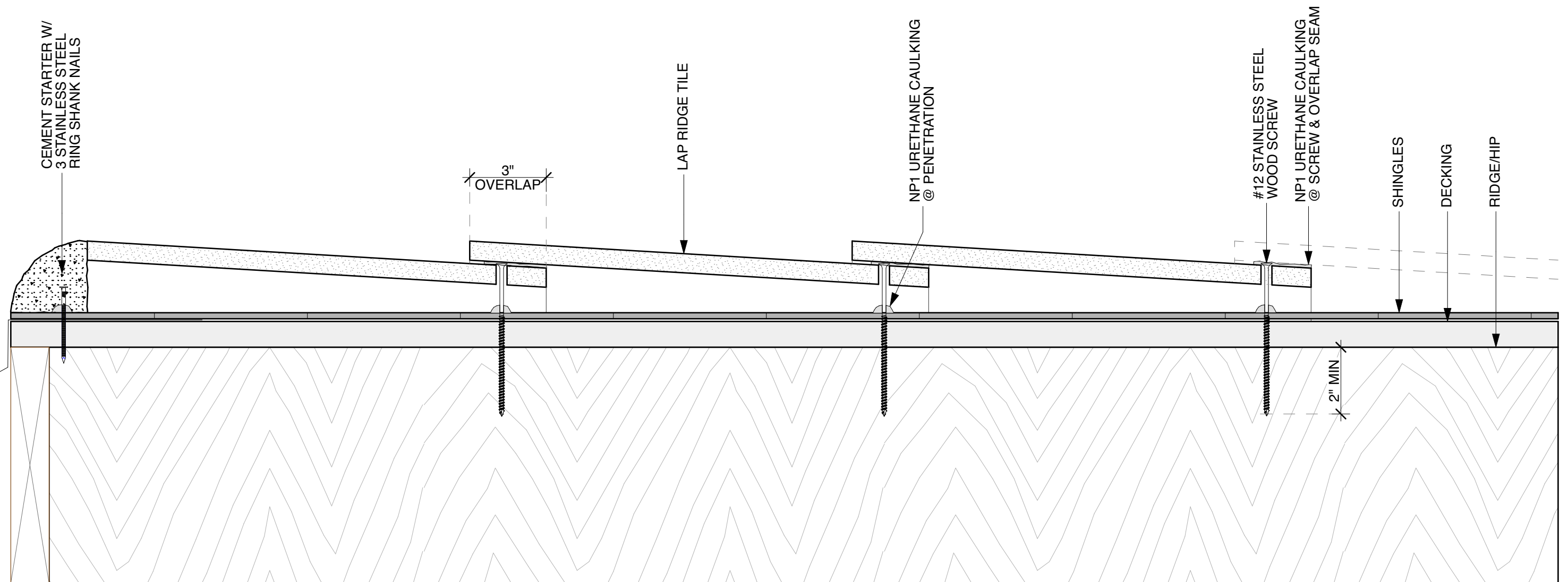

FIGURE 1

NOTE:

MIX TWO PARTS SAND WITH 1 PART PORTLAND TYPE 1-2 CEMENT TO BE USED @ 3 WAY MITRE AND HIP/GABLE STARTERS.

CEMENT HIP/GABLE STARTER USING (3) 3" STAINLESS STEEL RING SHANK NAILS WITH NP1 URETHANE CAULKING @ ROOF PENETRATION.

APPROX. 3" OVERLAP BETWEEN RIDGE TILES & APPLY NP1 URETHANE CAULKING @ SCREW AND OVERLAP SEAM TO SEAL.



HECKER RIDGE TILES
www.heckerridgetiles.com
 800.248.4537

NOTE: DO NOT BLOCK WATER ON VALLEYS OR WALL FLASHINGS

RIDGE TILE ASSEMBLY

LAP RIDGE TILE

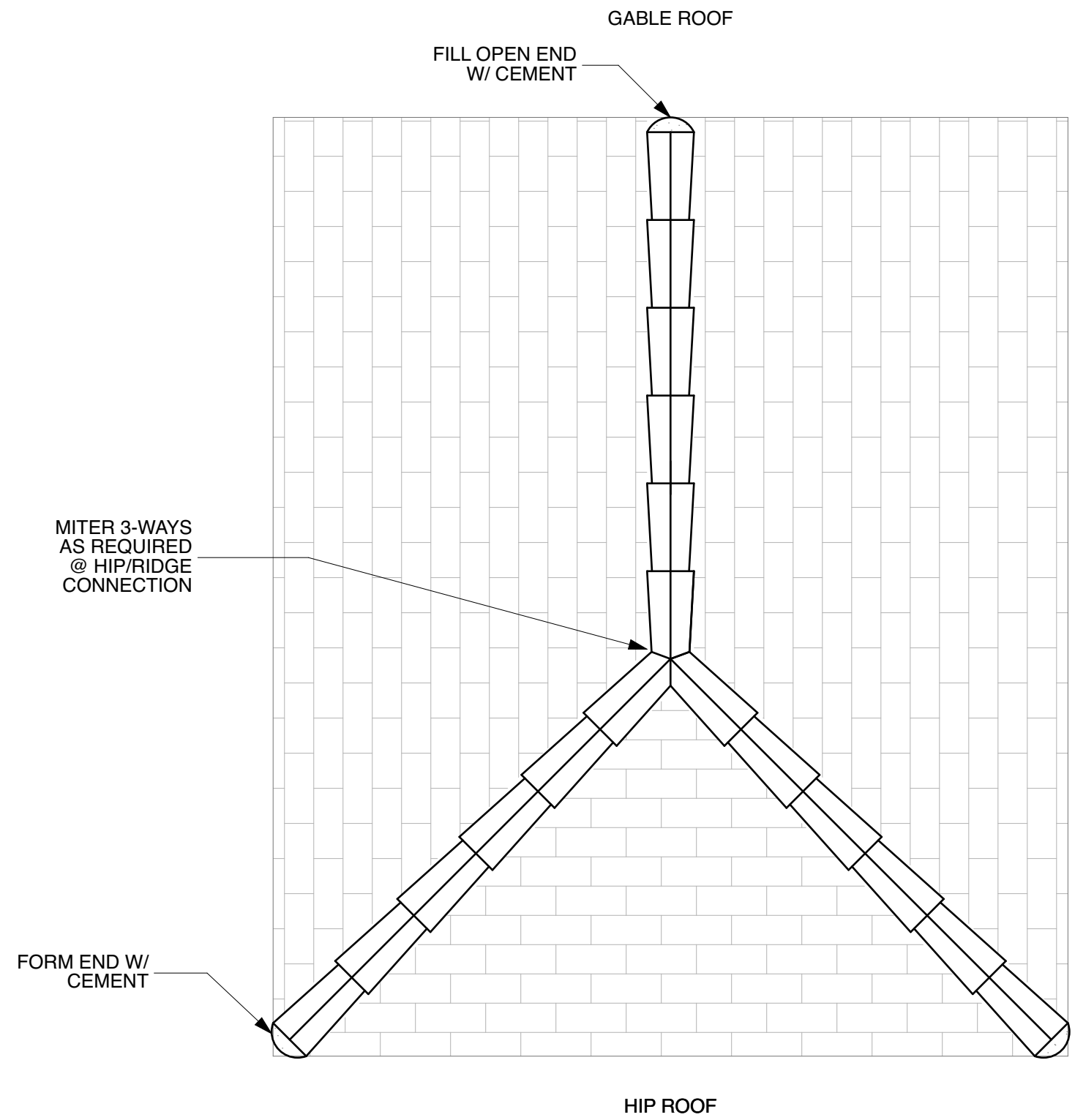

FIGURE 1

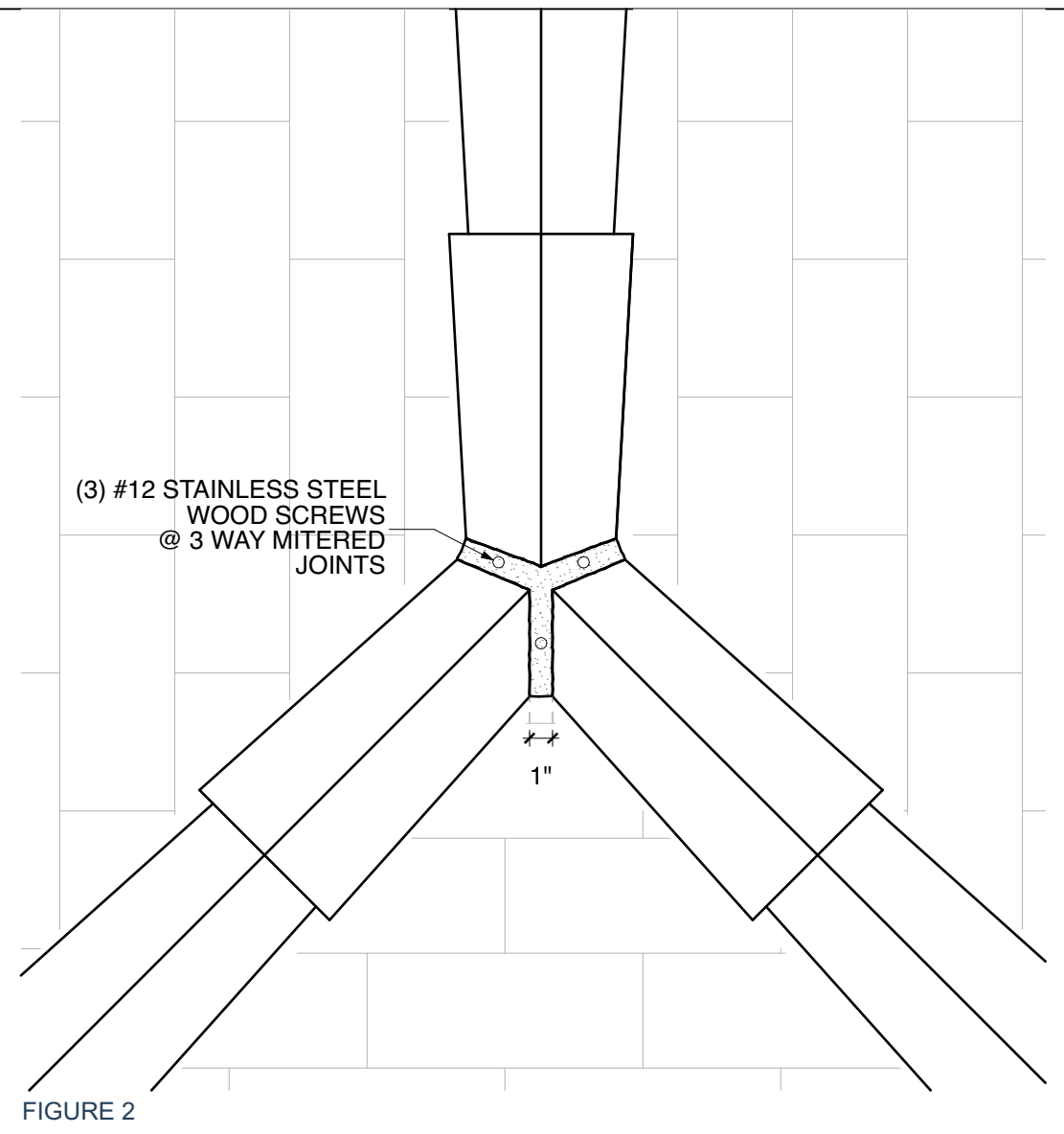

FIGURE 2

NOTE:
 MITER 3 WAYS, AS NECESSARY, USING (3) # 12 STAINLESS STEEL WOOD SCREWS W/ NP1 URETHANE CAULKING @ ROOF PENETRATION.
 FILL 1" JOINTS W/ 2 PART SAND & 1 PART PORTLAND TYPE 1-2 CEMENT MIXTURE.

NOTE: FOR WOOD CONSTRUCTION ONLY

LAP RIDGE TILE - ROOF CONDITIONS
 & 3 WAY MITER DETAIL

10

HECKER
 RIDGE TILES

HECKER RIDGE TILES
www.heckerridgetiles.com
 800.248.4537